



Laryngoskope  
Laryngoscopes  
Laryngoscopes  
Laringoscopi





2 - 6

Einweg-Laryngoskope  
Laryngoscopes à usage unique  
Single use laryngoscopes  
Laringoscopi monouso



8 - 13

Mehrweg-Laryngoskope gemäß Grünsystem  
Laryngoscopes réutilisables selon le système vert  
Green system reusable laryngoscopes  
Laringoscopio riutilizzabili secondo il sistema verde



16 - 19

Standard-Laryngoskop  
Laryngoscope réutilisables conventionnel  
Conventional reusable laryngoscopes  
Laringoscopi riutilizzabili convenzionali



22 - 25

Laryngoskop-Sätze und Zubehör  
Sets de laryngoscopes etc accesorios  
Laryngoscope sets and Accessories  
Set laringoscopio e accessori



26 - 28

Instrumente  
Instruments  
Instruments  
Strumenti



32 - 33

Inhaltsverzeichnis  
Index  
Alphabetical Index  
Indice alfabètico



34

Nummernverzeichnis  
Index numérique  
Numerical Index  
Indice numèrico





Einweg-Laryngoskope  
Laryngoscopes à usage unique  
Single use laryngoscopes  
Laringoscopi monouso



Aus Edelstahl & Kunststoff  
en acier inoxydable et plastique  
Stainless Steel & Plastic  
in acciaio inossidabile e plastica

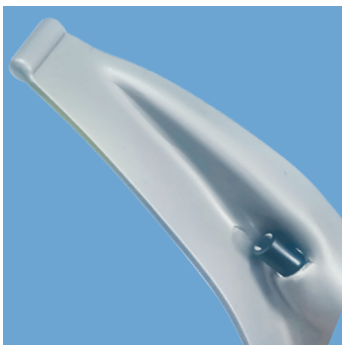

Top-Verarbeitung  
Finition impeccable  
Top workmanship  
Lavorazione superiore



Lichtleiter geschützt  
Fibre optique protégée  
Covered light guide  
Fibra ottica protetta



Einweg-Laryngoskop  
 Laryngoscope à usage unique  
 Single use laryngoscope  
 laringoscopio monouso

Laryngoskop-Spatel

- Grünsystem (ISO 7376)
- zum Einmalgebrauch
- Pack à 20 St.
- komplett aus Edelstahl
- unsteril

Laryngoscope Blades

- Green system (ISO 7376)
- Single patient use
- Pack of 20 pcs.
- Solid steel construction
- non sterile

Lame de laryngoscope

- système vert (ISO 7376)
- usage unique
- Paquet de 20 pièces
- entièrement en acier inoxydable
- non stérile

Lame laringoscopiche

- sistema verde (ISO 7376)
- monouso
- confezione da 20 pezzi
- completamente in acciaio inossidabile
- non sterile

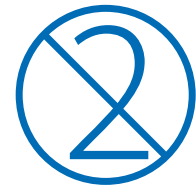
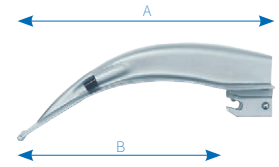

MACINTOSH

Fig.	A (mm)	B (mm)	Spatel lame blade lama
0	83,5	60	<b>NL4440</b>
1	96	72,5	<b>NL4441</b>
2	116	92,5	<b>NL4442</b>
3	139,5	116	<b>NL4443</b>
4	158	134,5	<b>NL4444</b>
5	175	151,5	<b>NL4445</b>

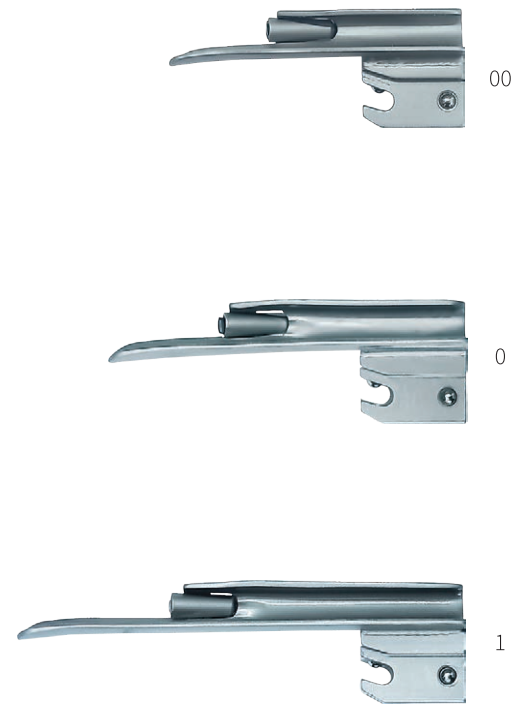

MILLER

Fig.	A (mm)	B (mm)	Spatel lame blade lama
00	68	44,5	<b>NL4539</b>
0	80	56,5	<b>NL4540</b>
1	103	79,5	<b>NL4541</b>
2	156,5	133	<b>NL4542</b>
3	194	170,5	<b>NL4543</b>
4	207	183,5	<b>NL4544</b>

### Laryngoskop-Spatel

- Grünsystem (ISO 7376)
- zum Einmalgebrauch
- Pack à 20 St.
- komplett aus Kunststoff
- unsteril

### Laryngoscope Blades

- Green system (ISO 7376)
- Single patient use
- Pack of 20 pcs.
- Solid plastic construction
- non sterile

### Lame de laryngoscope

- système vert (ISO 7376)
- usage unique
- Paquet de 20 pièces
- entièrement en plastique
- non stérile

### Lame laringoscopiche

- sistema verde (ISO 7376)
- monouso
- confezione da 20 pezzi
- completamente in plastica
- non sterile

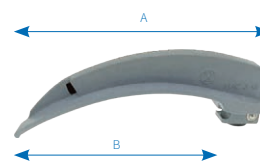

### MACINTOSH

Fig.	A (mm)	B (mm)	Spatel lame blade lama
0	82	58	<b>NL4420</b>
1	96	72	<b>NL4421</b>
2	115	92	<b>NL4422</b>
3	136	112	<b>NL4423</b>
4	160	136	<b>NL4424</b>

### MILLER

Fig.	A (mm)	B (mm)	Spatel lame blade lama
00	60	36	<b>NL4519</b>
0	80	55	<b>NL4520</b>
1	103	80	<b>NL4521</b>
2	152	130	<b>NL4522</b>
3	195	170	<b>NL4523</b>
4	215	188	<b>NL4524</b>

Einweg-Laryngoskop  
 Laryngoscope à usage unique  
 Single use laryngoscope  
 laringoscopio monouso

Laryngoskop

- mit hochleistungs LED-Lampe
- zum Einmalgebrauch
- Gebrauchsfertige Batterien enthalten
- Edelstahl & Kunststoff
- Pack à 10 St.
- unsteril

Laryngoscope

- with high powered LED
- Single Patient Use
- Ready to use batteries included
- Stainless steel & Plastic
- Pack of 10 pcs
- non sterile

Laryngoscope

- avec lampe LED haute puissance
- usage unique
- Piles prêtes à l'emploi incluses
- acier inoxydable et plastique
- Paquet de 10 pièces
- non stérile

Laringoscopio

- con lampada a LED ad alta potenza
- Uso monopaziente
- Batterie pronte all'uso incluse
- acciaio inossidabile e plastica
- confezione da 10 pezzi
- non sterile

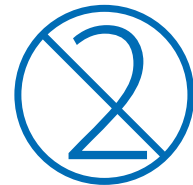
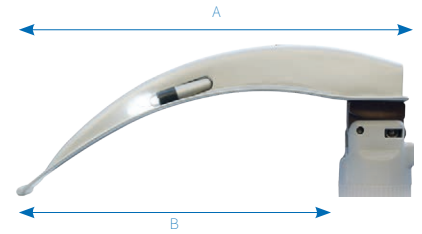

MACINTOSH

Fig.	A (mm)	B (mm)	UNIFI	Griff Manch Handle Manici	Farbe Couleur Color Colore
0	82	59	<b>NL5400</b>		
1	96	72	<b>NL5401</b>		
2	115	92	<b>NL5402</b>		
3	136	112	<b>NL5403</b>		
4	160	136	<b>NL5404</b>		



**UNIFI**

MILLER

Fig.	A (mm)	B (mm)	UNIFI	Griff Manch Handle Manici	Farbe Couleur Color Colore
00	60	36	<b>NL5499</b>		
0	80	55	<b>NL5500</b>		
1	103	80	<b>NL5501</b>		
2	152	130	<b>NL5502</b>		
3	195	170	<b>NL5503</b>		
4	215	188	<b>NL5504</b>		





#### Laryngoskop-Griff

- Grünsystem (ISO 7376)
- zum Einmalgebrauch
- für Kaltlicht / Grünsystem Spatel
- mit hochleistungs LED-Lampe
- Gebrauchsfertige Batterien enthalten
- Pack à 20 St.
- Massive Kunststoffkonstruktion
- unsteril

#### Laryngoscope Handle

- Green System (ISO 7376)
- Single Patient Use
- for Fiber optic / green system blades
- with high powered LED
- Ready to use batteries included
- Pack of 20 pcs
- Solid plastic construction
- non sterile

#### Poignée de laryngoscope

- système vert (ISO 7376)
- usage unique
- pour système vert les lames de lumière froide
- avec lampe LED haute puissance
- Piles prêtes à l'emploi incluses
- Paquet de 20 pièces
- Construction en plastique solide
- non stérile

#### Manico laringoscopia

- sistema verde (ISO 7376)
- Uso monopaziente
- per sistema verde lame a luce fredda
- con lampada a LED ad alta potenza
- Batterie pronte all'uso incluse
- confezione da 20 pezzi
- completamente in plastica
- non sterile

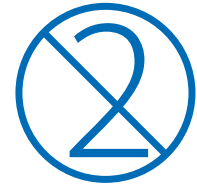

mittel  
moyenne  
medium  
medio



**NL6310**  
Ø 29 mm

klein  
petit  
small  
piccolo



**NL6311**  
Ø 20 mm





Mehrweg-Laryngoskope gemäß Grünsystem  
Laryngoscopes réutilisables selon le système vert  
Green system reusable laryngoscopes  
Laringoscopia riutilizzabili secondo il sistema verde



Hochleistungs-LEDs und -Lampen  
LED et lampes haute performance  
High performance LEDs & Lamps  
LED e lampade ad alte prestazioni



Top-Verarbeitung  
Finition impeccable  
Top workmanship  
Lavorazione superiore



Glasfaser in medizinischer Qualität  
Fibre optique de qualité médicale  
Medical grade fiber optics  
Fibra ottica di qualità medica

Mehrwegspatel gemäß Grünsystem  
 Lames réutilisables selon le système vert  
 Green system reusable blades  
 Lame riutilizzabili secondo il sistema verde

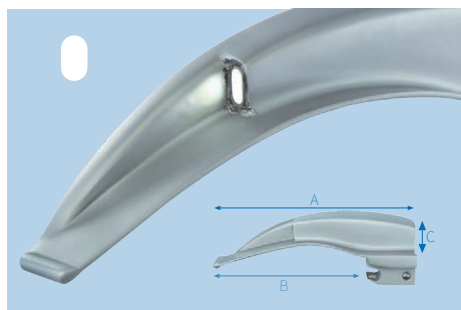

mit integriertem Lichtleiter  
 avec guide lumière intégré  
 with integrated light guide  
 con guida di luce integrata

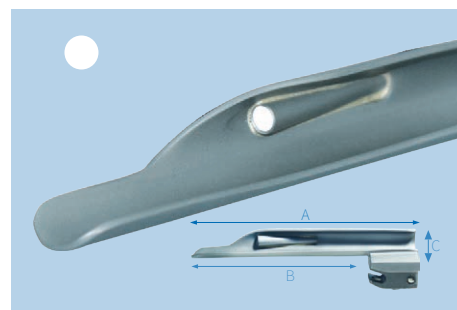

MACINTOSH

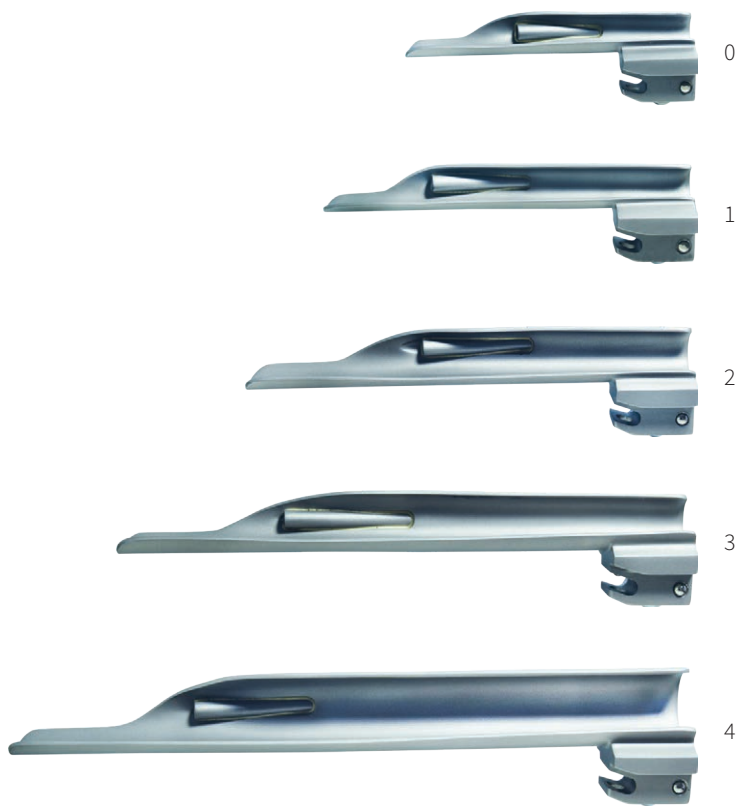

FOREGGER - WISCONSIN

Fig.	A (mm)	B (mm)	C (mm)	Spatel lame blade lama
00	65	41	8	<b>NL1399</b>
0	82	59	9	<b>NL1400</b>
1	96	72	14	<b>NL1401</b>
2	115	92	15	<b>NL1402</b>
3	136	112	16	<b>NL1403</b>
4	160	136	16	<b>NL1404</b>
5	180	160	16	<b>NL1405</b>

Fig.	A (mm)	B (mm)	C (mm)	Spatel lame blade lama
0	93	70	12	<b>NL1600</b>
1	110	87	13	<b>NL1601</b>
2	133	110	15	<b>NL1602</b>
3	160	138	16	<b>NL1603</b>
4	190	167	19	<b>NL1604</b>

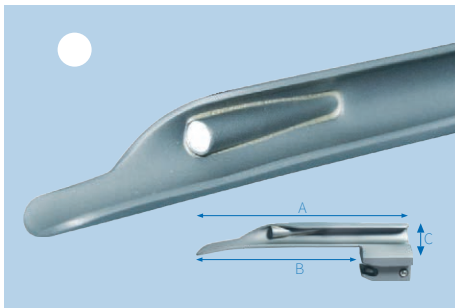

mit integriertem Lichtleiter  
avec guide lumière intégré  
with integrated light guide  
con guida di luce integrata

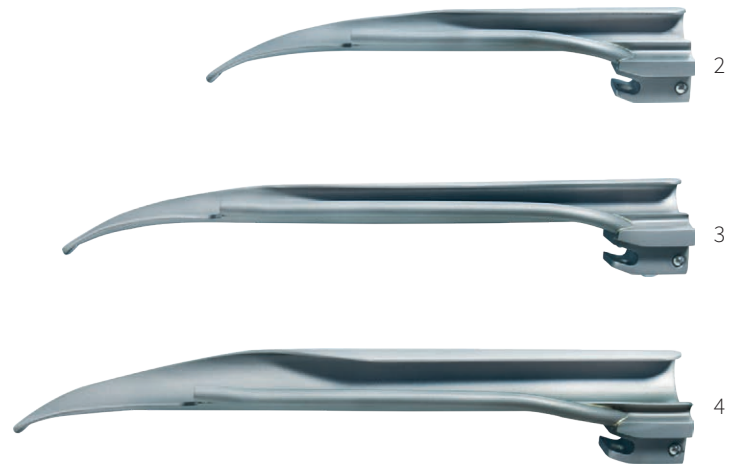
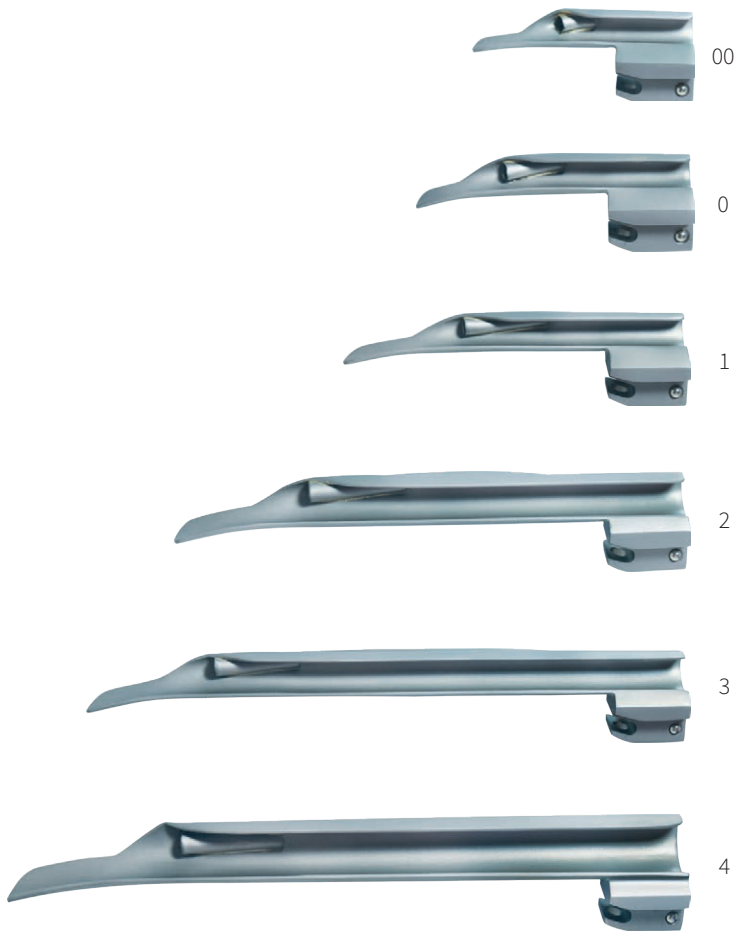
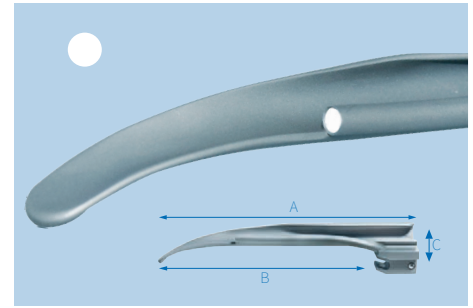

MILLER

Fig.	A (mm)	B (mm)	C (mm)	Spatel lame blade lama
00	60	36	8	<b>NL1499</b>
0	80	54	8	<b>NL1500</b>
1	103	78	8	<b>NL1501</b>
2	152	130	10	<b>NL1502</b>
3	195	170	12	<b>NL1503</b>
4	215	188	15	<b>NL1504</b>

MILLER amerikanisches Modell  
MILLER modèle américain  
MILLER American pattern  
MILLER modello americano

Fig.	A (mm)	B (mm)	C (mm)	Spatel lame blade lama
2	154	130	11	<b>NL1512</b>
3	195	170	12	<b>NL1513</b>
4	205	180	15	<b>NL1514</b>

Mehrwegspatel gemäß Grünsystem für spezielle Anwendungen  
 Lames réutilisables selon le système vert pour les applications spécialisées  
 Green system reusable specialty blades  
 Lame riutilizzabili secondo il sistema verde per applicazioni speciali

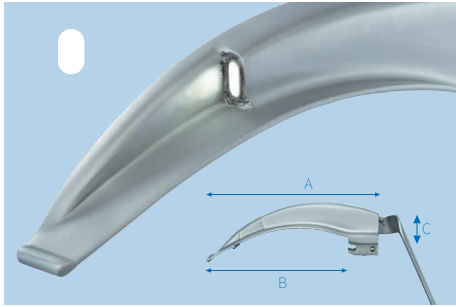

mit integriertem Lichtleiter  
 avec guide lumière intégré  
 with integrated light guide  
 con guida di luce integrata

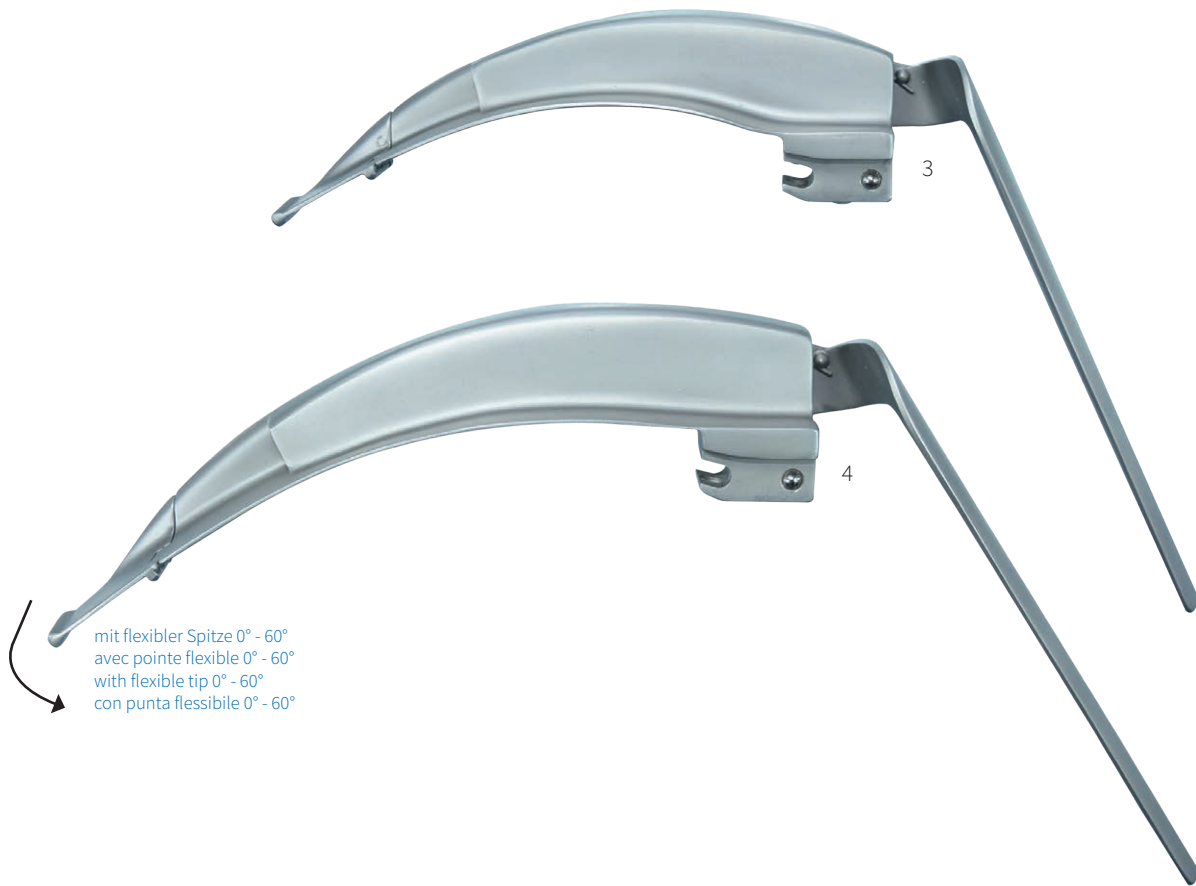

mit flexibler Spitze 0° - 60°  
 avec pointe flexible 0° - 60°  
 with flexible tip 0° - 60°  
 con punta flessibile 0° - 60°

(flexibler Spitze)  
 (pointe flexible)  
 (flexible tip)  
 (punta flessibile)

Spatel  
 lame  
 blade  
 lama

Fig.	A (mm)	B (mm)	C (mm)	
2	115	92	15	<b>NL1302</b>
3	136	112	16	<b>NL1303</b>
4	160	136	16	<b>NL1304</b>

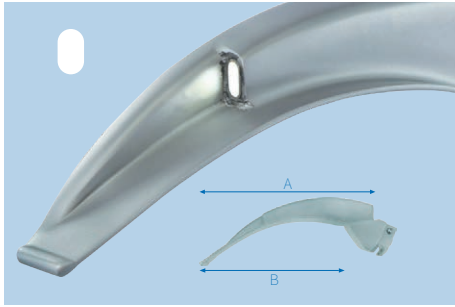

mit integriertem Lichtleiter  
avec guide lumière intégré  
with integrated light guide  
con guida di luce integrata

POLIO

Fig.	A (mm)	B (mm)	Spatel lame blade lama
3	150	117	<b>NL1323</b>
4	175	143	<b>NL1324</b>

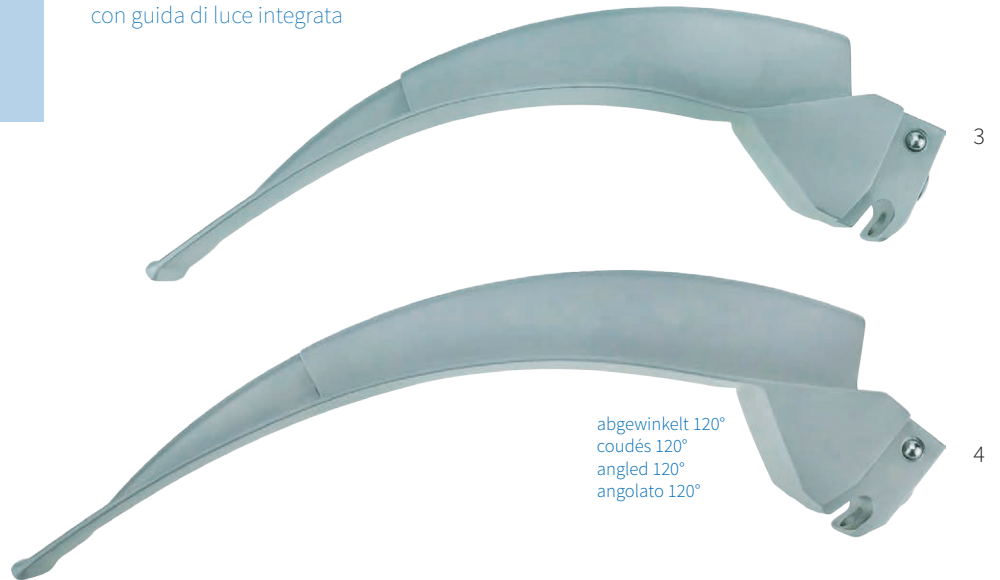

abgewinkelt 120°  
coudés 120°  
angled 120°  
angolato 120°

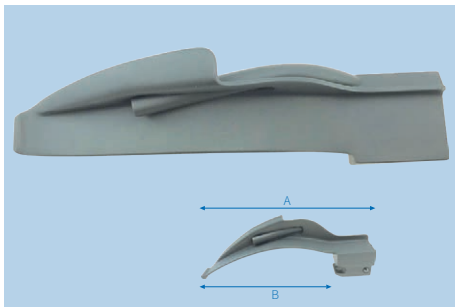

mit integriertem Lichtleiter  
avec guide lumière intégré  
with integrated light guide  
con guida di luce integrata

CALLANDER (modif. MACINTOSH)

Fig.	A (mm)	B (mm)	Spatel lame blade lama
2	115	92	<b>NL1332</b>
3	136	122	<b>NL1333</b>
4	160	136	<b>NL1334</b>



Mehrweggriffe gemäß Grünsystem  
 Manches réutilisables selon le système vert  
 Green system reusable handles  
 Manici riutilizzabili secondo il sistema verde

- Laryngoskop-Griff
- Grünsystem
  - Mehrweg
  - für Kaltlicht-Spatel
  - mit Ultra-Leistungs-LED
  - komplett aus Edelstahl

- Poignée de laryngoscope
- système vert
  - réutilisable
  - pour les lames de lumière froide
  - avec LED ultra-puissant
  - entièrement en acier inoxydable

- Laryngoscope Handle
- Green System
  - Reusable
  - for fiber optic blades
  - with Ultra powered LED
  - Stainless steel

- Manico laringoscopio
- sistema verde
  - riutilizzabile
  - per lame a luce fredda
  - con LED ad alta potenza
  - completamente in acciaio inossidabile



**ULTRA-POWER**  
**LED**  
**3X** brighter  
 than **XENON**



**NL6000**



**NL6001**



**NL6002**

Durchmesser  
 diamètre  
 diameter  
 diametro

mittel / moyen medium / medio	<b>NL6000</b>	Ø 29 mm
klein / petit small / piccolo	<b>NL6001</b>	Ø 22 mm
kurz / court stubby / breve	<b>NL6002</b>	Ø 33 mm

Ersatzlampe /  
 Lampe de réserve /  
 Spare lamps /  
 Lampada di ricambio /

**NL6826**



**NL6826**



## Laryngoskop-Griff

- Grünsystem (ISO 7376)
- Mehrweg
- für Kaltlicht-Spatel
- mit Xenon-Lampe
- komplett aus Edelstahl

## Laryngoscope Handle

- Green System (ISO 7376)
- Reusable
- for fiber optic blades
- with Xenon lamp
- Stainless steel

## Poignée de laryngoscope

- système vert (ISO 7376)
- réutilisable
- pour les lames de lumière froide
- avec lampe Xenon
- entièrement en acier inoxydable

## Manico laringoscopio

- sistema verde (ISO 7376)
- riutilizzabile
- per lame a luce fredda
- con lampada Xenon
- completamente in acciaio inossidabile



**NL6020**

**NL6021**

**NL6022**

		Durchmess- er  diamètre diametro diameter diametro
mittel / moyen medium / medio	<b>NL6020</b>	Ø 29 mm
klein / petit small / piccolo	<b>NL6021</b>	Ø 19 mm
kurz / court stubby / breve	<b>NL6022</b>	Ø 33 mm

Ersatzlampe / **NL6800**  
 Lampe de réserve /  
 Spare lamps /  
 Lampada di ricambio /

2.5 V



**NL6800**





Standard-Laryngoskop  
Laryngoscope réutilisables conventionnel  
Conventional reusable Laryngoscopes  
Laringoscopi riutilizzabili convenzionali



aus Edelstahl  
en acier inoxydable  
Stainless steel construction  
in acciaio inox



Top-Verarbeitung  
Finition impeccable  
Top workmanship  
Lavorazione superiore



Natürliches warmes Licht  
Lumière naturelle chaude  
Natural warm light  
Luce calda naturale



Standard Mehrweg-Spatel  
Lames réutilisables conventionnelles  
Conventional reusable blades  
Lame convenzionali riutilizzabili

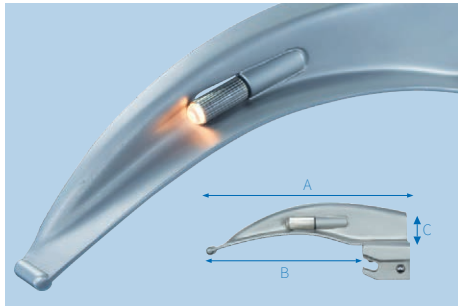

mit Warmlicht Lampe  
avec lampe à lumière chaude  
with warm light lamp  
con lampada warmlight

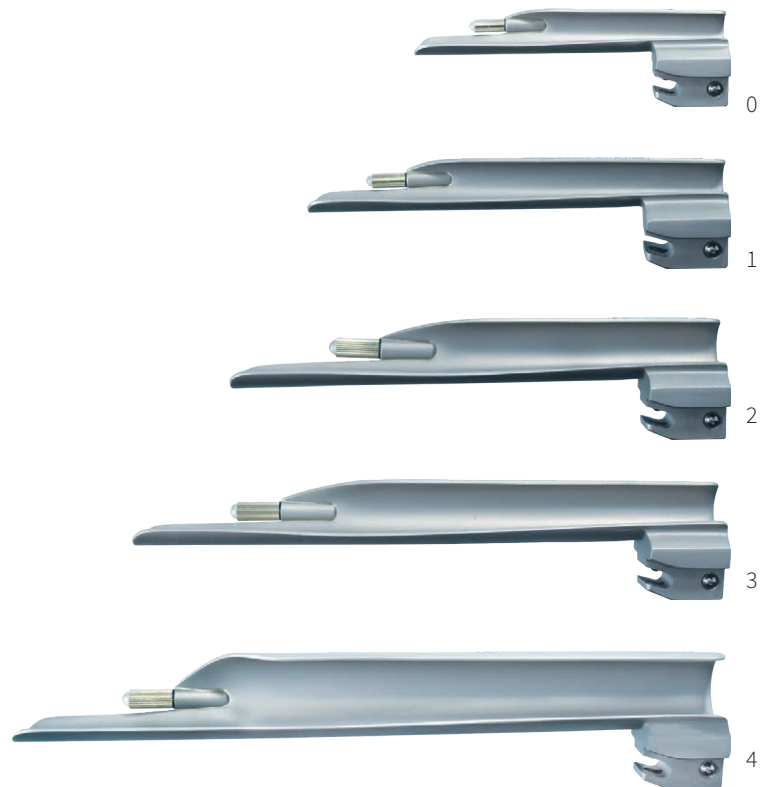
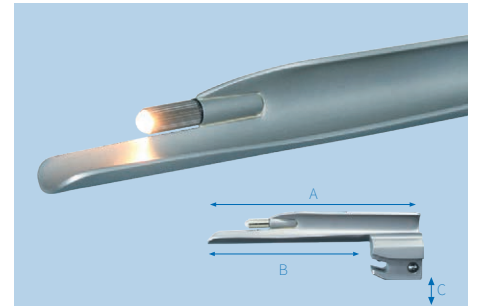

MACINTOSH

Fig.	A (mm)	B (mm)	C (mm)	Spatel lame blade lama	Ersatzlampe lampe de réserve spare lamp lampada di ricambio
00	65	41	8	<b>NL3399</b>	<b>NL6810</b>
0	82	59	9	<b>NL3400</b>	<b>NL6810</b>
1	96	72	14	<b>NL3401</b>	<b>NL6812</b>
2	115	92	15	<b>NL3402</b>	<b>NL6812</b>
3	136	112	16	<b>NL3403</b>	<b>NL6812</b>
4	160	136	16	<b>NL3404</b>	<b>NL6812</b>
5	180	160	16	<b>NL3405</b>	<b>NL6812</b>

FOREGGER-WISCONSIN

Fig.	A (mm)	B (mm)	C (mm)	Spatel lame blade lama	Ersatzlampe lampe de réserve spare lamp lampada di ricambio
00	78	55	8	<b>NL3599</b>	<b>NL6810</b>
0	93	70	9.5	<b>NL3600</b>	<b>NL6810</b>
1	110	87	9	<b>NL3601</b>	<b>NL6810</b>
2	133	110	15	<b>NL3602</b>	<b>NL6812</b>
3	160	138	16	<b>NL3603</b>	<b>NL6812</b>
4	190	167	19	<b>NL3604</b>	<b>NL6812</b>

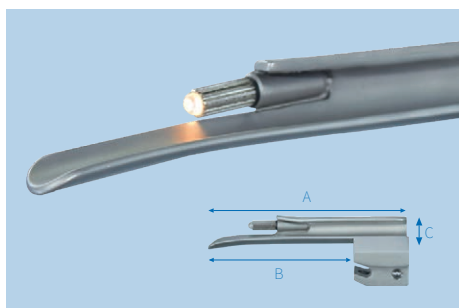

mit Warmlicht Lampe  
avec lampe à lumière chaude  
with warm light lamp  
con lampada warmlight

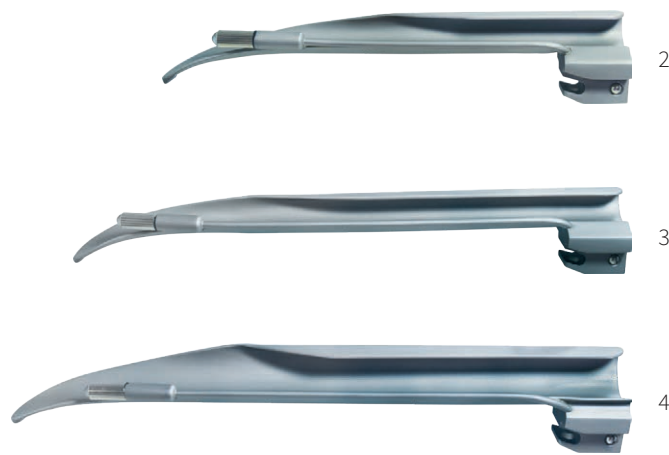
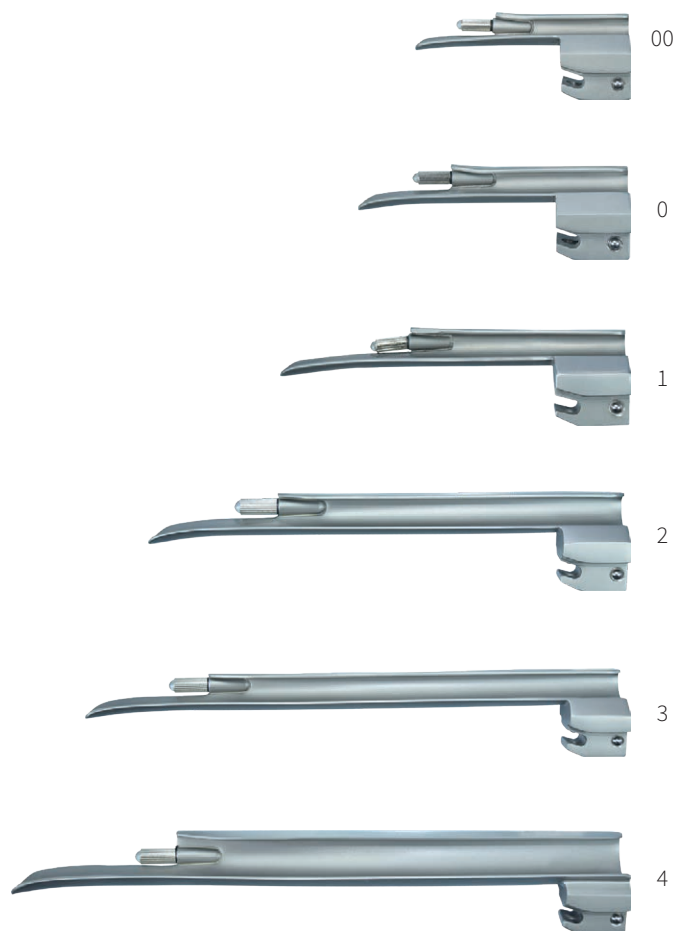
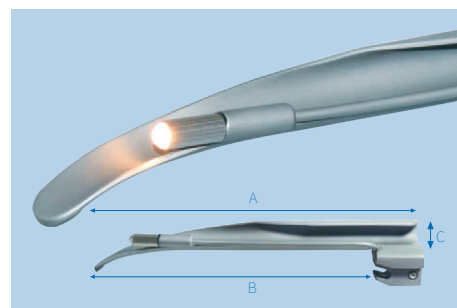

## MILLER

Fig.	A (mm)	B (mm)	C (mm)	Spatel lame blade lama	Ersatzlampe lampe de réserve spare lamp lampada di ricambio
00	58	36	8	<b>NL3499</b>	<b>NL6810</b>
0	80	54	8	<b>NL3500</b>	<b>NL6810</b>
1	103	78	8	<b>NL3501</b>	<b>NL6810</b>
2	152	130	10	<b>NL3502</b>	<b>NL6812</b>
3	195	170	12	<b>NL3503</b>	<b>NL6812</b>
4	215	188	15	<b>NL3504</b>	<b>NL6812</b>

## MILLER amerikanisches Modell MILLER modèle américain MILLER American pattern MILLER modello americano

Fig.	A (mm)	B (mm)	C (mm)	Spatel lame blade lama	Ersatzlampe lampe de réserve spare lamp lampada di ricambio
2	154	130	11	<b>NL3512</b>	<b>NL6812</b>
3	195	170	12	<b>NL3513</b>	<b>NL6812</b>
4	205	180	15	<b>NL3514</b>	<b>NL6812</b>

Standard Mehrwegspatel für Spezialanwendungen  
 Lames réutilisables conventionnelles pour les applications spécialisées  
 Conventional reusable specialty blades  
 Lame convenzionali riutilizzabili per applicazioni speciali

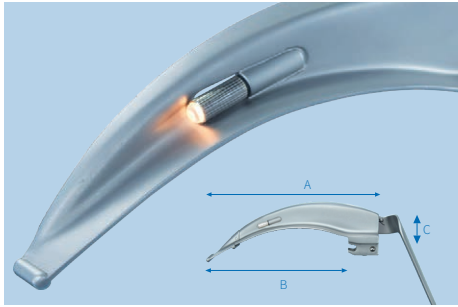

mit Warmlicht Lampe  
 avec lampe à lumière chaude  
 with warm light lamp  
 con lampada warmlight

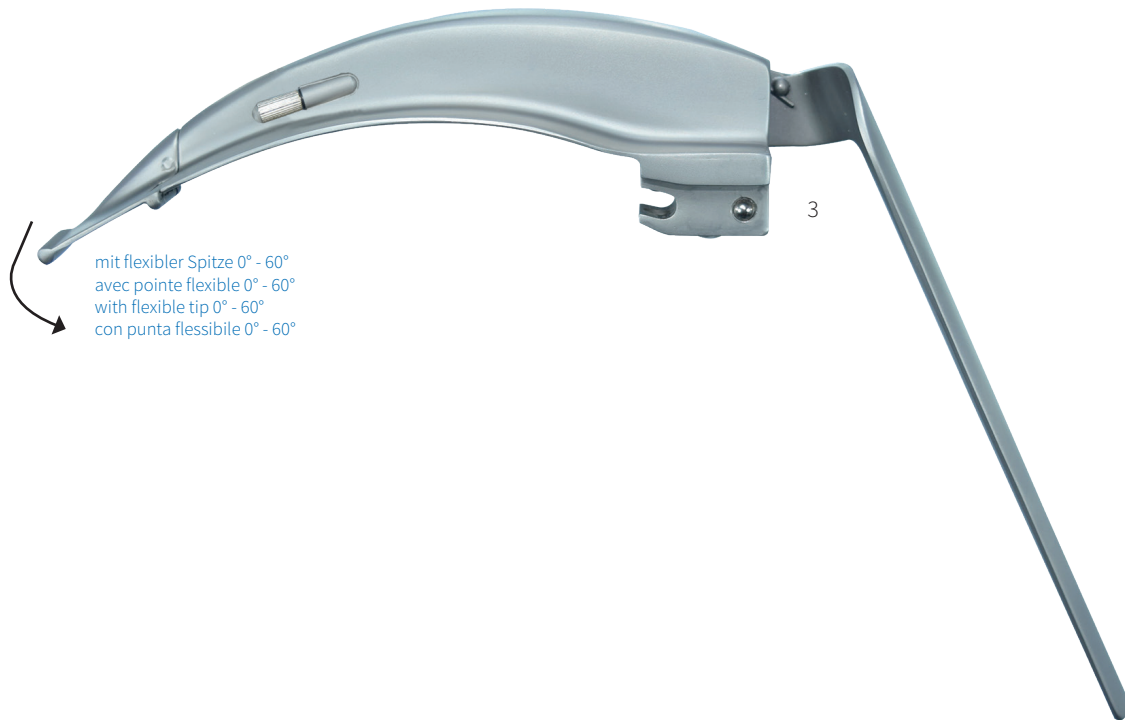

mit flexibler Spitze 0° - 60°  
 avec pointe flexible 0° - 60°  
 with flexible tip 0° - 60°  
 con punta flessibile 0° - 60°

(flexibler Spitze)  
 (pointe flexible)  
 (flexible tip)  
 (punta flessibile)

Spatel  
 lame  
 Blade  
 lama

Fig.	A (mm)	B (mm)	C (mm)	
2	115	92	15	<b>NL3302</b>
3	136	112	16	<b>NL3303</b>
4	160	136	16	<b>NL3304</b>

#### Laryngoskop-Griff

- Standard
- Mehrweg
- für Warmlicht

#### Laryngoscope Handle

- Conventional
- Reusable
- for warm light

#### Manches de laryngoscope

- conventionnelle
- réutilisable
- für warmes Licht

#### Manico laringoscopio

- convenzionali
- riutilizzabile
- per luce calda



**NL6120**

**NL6121**

**NL6122**

**NL6123**

	Edelstahl inox stainless inox	Verchromt chromé chrome plated cromato	Durchmesser diamètre diameter diametro
mittel / moyenne medium / medio	<b>NL6120</b>	<b>NL6110</b>	Ø 29 mm
klein / petit small / piccolo	<b>NL6121</b>	<b>NL6111</b>	Ø 19 mm
kurz / court stubby / breve	<b>NL6122</b>		Ø 33 mm
groß / grand large / grande	<b>NL6123</b>		Ø 37 mm



**NL6810**



**NL6812**

Ersatzlampe  
Lampe de réserve  
Spare lamps  
Lampada di ricambio

klein / petit small / piccolo	<b>NL6810</b>
groß / grande large / grande	<b>NL6812</b>







Laryngoskop-Sätze  
Sets de laryngoscopes  
Laryngoscope sets  
Set laringoscopio



Sätze  
Sets  
Sets  
Sets

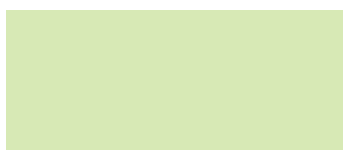
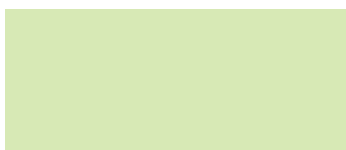

mit Kaltlichtleiter  
 avec guide lumière  
 with fiber optic light guide  
 con guida di luce



ULTRA-POWER  
**LED**  
 3X brighter  
 than XENON



Laryngoskop-Satz, Kunststoff-Koffer  
 Sets de laryngoscopes, étui plastique  
 Laryngoscope sets, plastic case  
 Set laringoscopio, caso in plastica

	Spatel lame blade lama	Griffe manches handle manici	Koffer étui case caso	integriertem intégré integrated integrata
MACINTOSH	2, 3, 4	mittel / moyenne medium / medio	klein / petit small / piccolo	<b>NL1483</b>
	1, 2, 3, 4	mittel / moyenne medium / medio	groß / grand large / grande	<b>NL1484</b>
MILLER	1, 2, 3	mittel / moyenne medium / medio	klein / petit small / piccolo	<b>NL1582</b>
	2, 3, 4	mittel / moyenne medium / medio	groß / grand large / grande	<b>NL1583</b>
	1, 2, 3, 4	mittel / moyenne medium / medio	groß / grand large / grande	<b>NL1584</b>
FOREGGER-WISCONSIN	2, 3, 4	mittel / moyenne medium / medio	groß / grand large / grande	<b>NL1683</b>
	1, 2, 3, 4	mittel / moyenne medium / medio	groß / grand large / grande	<b>NL1684</b>

mit Kaltlichtleiter  
avec guide lumière  
with fiber optic light guide  
con guida di luce



**XENON**



Laryngoskop-Sätz, Kunststoff-Koffer  
Sets de laryngoscopes, étui plastique  
Laryngoscope sets, plastic case  
Set laringoscopio, caso in plastica

	Spatel lame blade lama	Griffe manches handle manici	Koffer étui case caso	integriertem intégré integrated integrata
MACINTOSH	1, 2, 3	mittel / moyenne medium / medio	klein / petit small / piccolo	<b>NL1462</b>
	2, 3, 4	mittel / moyenne medium / medio	klein / petit small / piccolo	<b>NL1463</b>
	1, 2, 3, 4	mittel / moyenne medium / medio	groß / grand large / grande	<b>NL1464</b>
MILLER	1, 2, 3	mittel / moyenne medium / medio	klein / petit small / piccolo	<b>NL1562</b>
	2, 3, 4	mittel / moyenne medium / medio	groß / grand large / grande	<b>NL1563</b>
	1, 2, 3, 4	mittel / moyenne medium / medio	groß / grand large / grande	<b>NL1564</b>
FOREGGER-WISCONSIN	2, 3, 4	mittel / moyenne medium / medio	groß / grand large / grande	<b>NL1663</b>
	1, 2, 3, 4	mittel / moyenne medium / medio	groß / grand large / grande	<b>NL1664</b>

mit Warmlicht Lampe  
 avec lampe à lumière chaude  
 with warm light lamp  
 con lampada warmlight



Laryngoskop-Sätz, Kunststoff-Koffer  
 Sets de laryngoscopes, étui plastique  
 Laryngoscope sets, plastic case  
 Set laringoscopio, caso in plastica

	Spatel lame blade lama	Griffe manches handles manici	Koffer étui case caso	
MACINTOSH	2, 3, 4	mittel / moyenne medium / medio	klein / petit small / piccolo	<b>NL3463</b>
	1, 2, 3, 4	mittel / moyenne medium / medio	groß / grand large / grande	<b>NL3464</b>
MILLER	1, 2, 3	mittel / moyenne medium / medio	klein / petit small / piccolo	<b>NL3562</b>
	2, 3, 4	mittel / moyenne medium / medio	groß / grand large / grande	<b>NL3563</b>
	1, 2, 3, 4	mittel / moyenne medium / medio	groß / grand large / grande	<b>NL3564</b>
FOREGGER-WISCONSIN	2, 3, 4	mittel / moyenne medium / medio	klein / petit small / piccolo	<b>NL3663</b>
	1, 2, 3, 4	mittel / moyenne medium / medio	groß / grand large / grande	<b>NL3664</b>



Kunststoff-Koffer allein, für 1 - 3 Spatel  
étui plastique seul, pour 1 - 3 lames  
Plastic case only, for 1 - 3 blades  
caso in plastica solo 1 - 3 lame

klein / petit **NL6903**  
small / piccolo

Einlage allein, für 1 - 3 Spatel und 1 Griff  
Insert seul, pour 1 - 3 lames et 1 manche  
Insert only, for 1 - 3 blades and 1 handle  
inserto solo 1 - 3 lame e 1 manici

Spatel / lames  
blades / lame  
gerade / droites **NL6923**  
straight / retta  
gebogen / courbes **NL6913**  
curved / curva



Kunststoff-Koffer allein, für 4 - 5 Spatel  
Étui plastique seul, pour 4 - 5 lames  
Plastic case only, for 4 - 5 blades  
Caso in plastica solo 4 - 5 lame

groß / grand **NL6905**  
large / grande

Einlage allein, für 4 - 5 Spatel und 1 Griff  
Insert seul, pour 4 - 5 lames et 1 manche  
Insert only, for 4 - 5 blades and 1 handle  
inserto solo 4 - 5 lame e 1 manici

Spatel / lames  
blades / lame  
gerade / droites **NL6925**  
straight / retta  
gebogen / courbes **NL6915**  
curved / curva



Kunststoff-Koffer allein, für 6 - 7 Spatel  
Étui plastique seul, pour 6 - 7 lames  
Plastic case only, for 6 - 7 blades  
caso in plastica solo 6 - 7 lame

extra groß / extra grand **NL6907**  
extra large / extra grande

Einlage allein, für 6 - 7 Spatel und 1 Griff  
Insert seul, pour 6 - 7 lames et 1 manche  
Insert only, for 6 - 7 blades and 1 handle  
inserto solo 6 - 7 lame e 1 manici

Spatel / lames  
blades / lame  
gerade / droites **NL6927**  
straight / retta  
gebogen / curved **NL6917**  
curved / curva

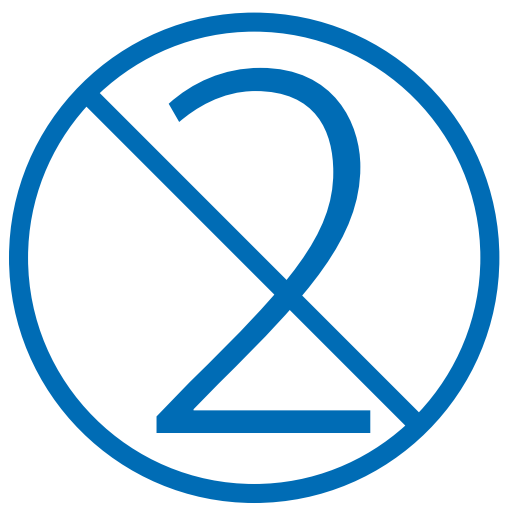
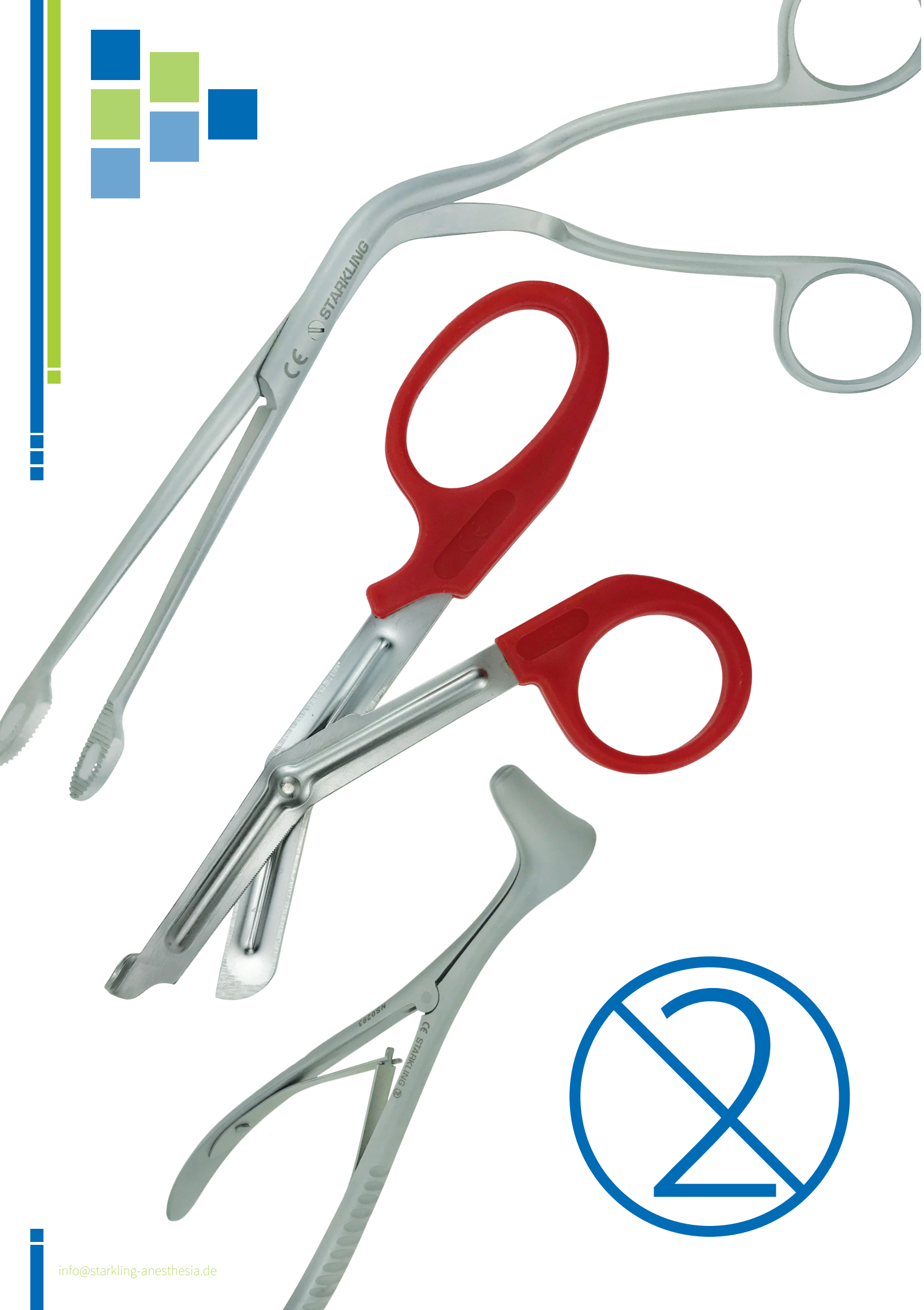

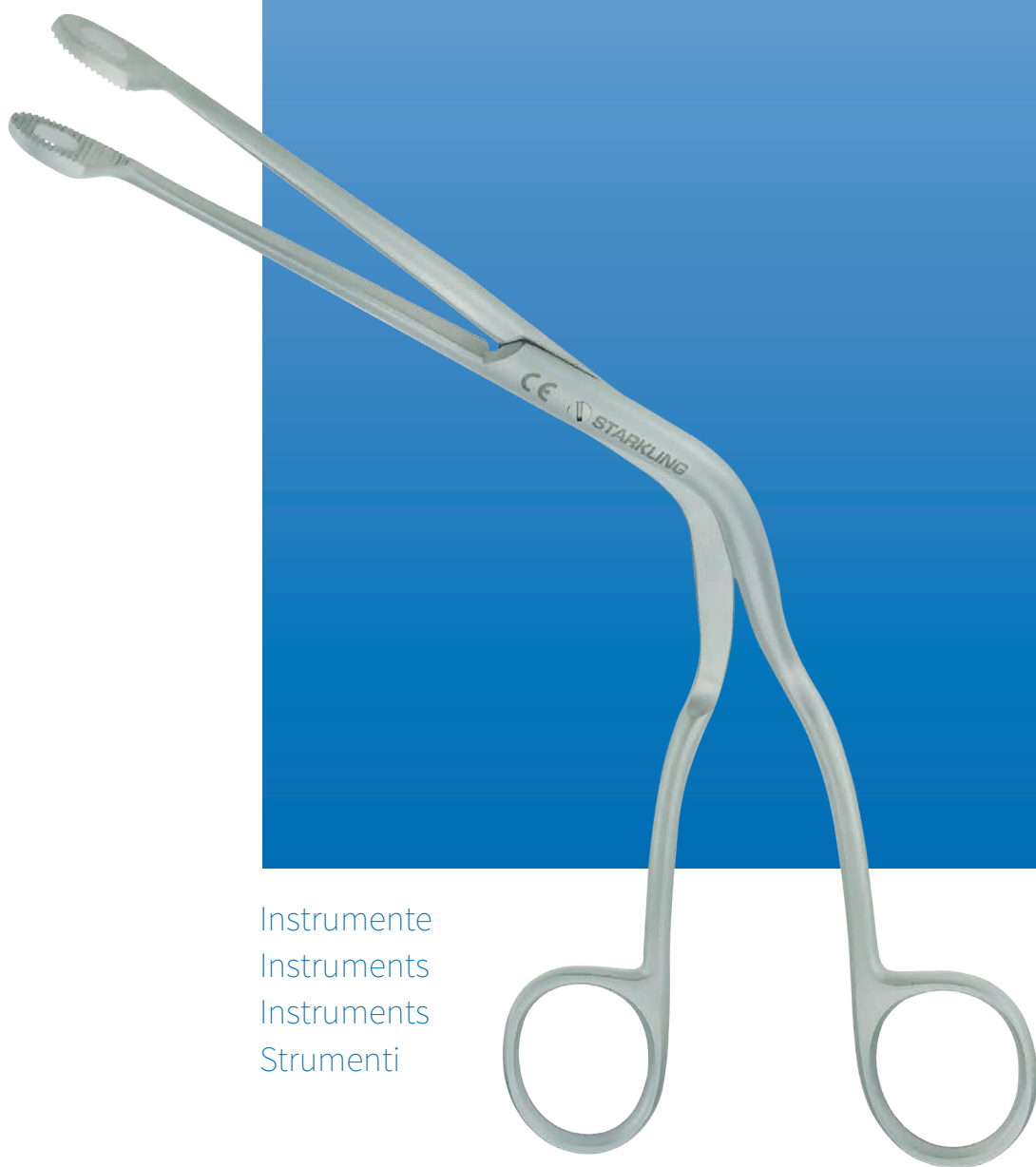

Instrumente  
Instruments  
Instruments  
Strumenti



Intubation  
L'intubation  
Intubation  
Intubazione



Instrumente  
Instruments  
Instruments  
Strumenti

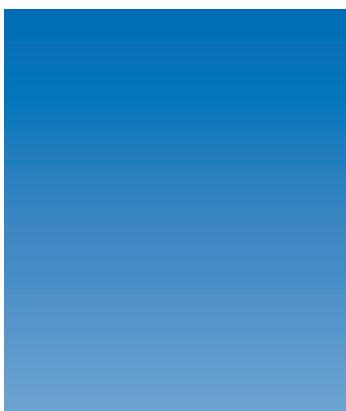

- Einmalgebrauch
- Pack à 10 St.
- aus Edelstahl
- unsteril
- Single patient use
- Pack of 10 pcs.
- Stainless steel
- Non sterile
- Utilisation d'un seul patient
- Paquet de 10 pièces
- entièrement en acier inoxydable
- non stérile
- Monouso
- confezione da 10 pezzi
- completamente in acciaio inossidabile
- non sterile

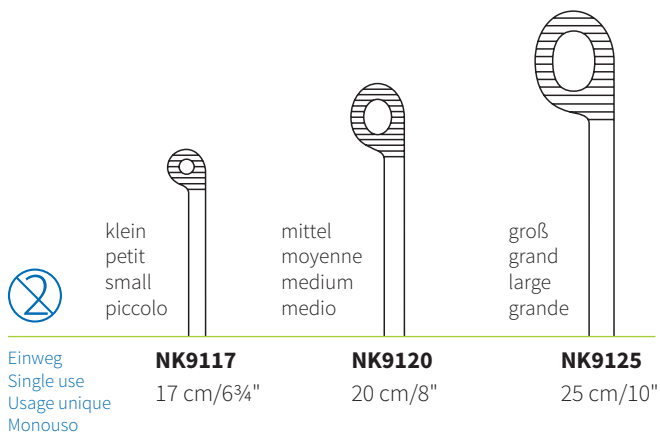

- Mehrweg
- aus Edelstahl
- Reusable
- Stainless steel
- Réutilisable
- acier inoxydable
- Reutilizable
- acciaio inossidabile

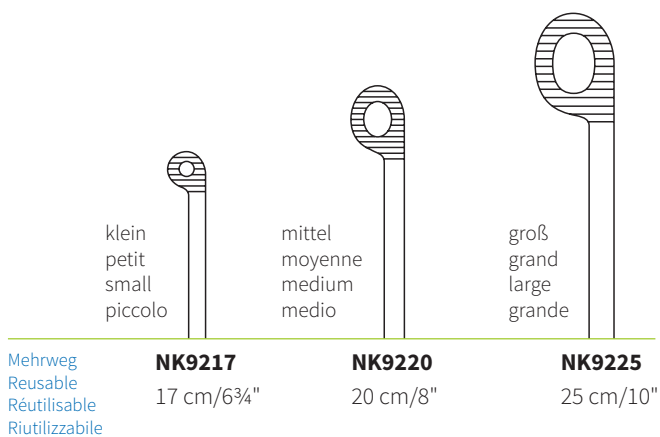

MAGILL



- Einmalgebrauch
- Pack à 20 St.
- aus Edelstahl
- unsteril
- Single patient use
- Pack of 20 pcs.
- Stainless steel
- Non sterile
- Utilisation d'un seul patient
- Paquet de 20 pièces
- entièrement en acier inoxydable
- non stérile
- Monouso
- confezione da 20 pezzi
- completamente in acciaio inossidabile
- non sterile



Kunststoff-Griff  
Poignée en plastique  
Plastic handgrip  
Impugnatura in plastica



Schwarz  
Noir  
Black  
Nero

**SY1318.NB**  
18,5 cm/7¼"



Blau  
Bleu  
Blue  
Blu

**SY1318.NU**  
18,5 cm/7¼"



Rot  
Rouge  
Red  
Rosso

**SY1318.NR**  
18,5 cm/7¼"

- Einmalgebrauch
  - Pack à 20 St.
  - aus Edelstahl
  - unsteril
- Utilisation d'un seul patient
  - Paquet de 20 pièces
  - entièrement en acier inoxydable
  - non stérile
- Single patient use
  - Pack of 20 pcs.
  - Stainless steel
  - Non sterile
- Monouso
  - confezione da 20 pezzi
  - completamente in acciaio inossidabile
  - non sterile



HARTMANN  
15 cm/6"

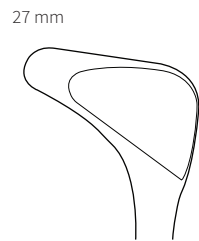

NS0291  
Fig. 1

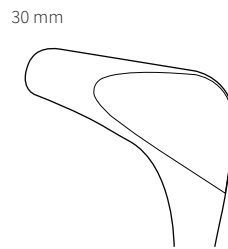

NS0292  
Fig. 2



NS0293  
Fig. 3



A - Z

Inhaltsverzeichnis  
Index  
Alphabetical Index  
Indice alphabético

1 - 9

Nummernverzeichnis  
Index numérique  
Numerical Index  
Indice numérico

## Deutsch

### C

CALLANDER (modif. MACINTOSH) Mehrwegspatel gemäß Grünsystem für spezielle Anwendungen... 11

### E

Einweg-Laryngoskop... 2-5  
Einweg-Laryngoskopgriff... 5  
Ersatzkartusche... 12  
Ersatzlampe... 13-19

### F

FOREGGER - WISCONSIN Mehrwegspatel gemäß Grünsystem... 8  
FOREGGER-WISCONSIN Standard Mehrweg-Spatel... 16

### H

HARTMANN Nasenspekulum... 30

### L

Laryngoskop-Sätze... 22-24

### M

MACINTOSH Einweg-Laryngoskop... 2  
MACINTOSH Einweg-Metall-Plastik-Laryngoskopspatel... 3  
MACINTOSH Mehrwegspatel gemäß Grünsystem... 8  
MACINTOSH Standard Mehrweg-Spatel... 16  
MAGILL Intubationszange... 28  
Mehrweggriffe gemäß Grünsystem... 12-13  
Mehrwegspatel gemäß Grünsystem für spezielle Anwendungen... 8-13  
Anwendungen... 10  
MILLER Einweg-Laryngoskop... 2  
MILLER Einweg-Metall-Plastik-Laryngoskopspatel... 3  
MILLER Mehrwegspatel gemäß Grünsystem... 9  
MILLER Standard Mehrweg-Spatel... 17

### P

POLIO Mehrwegspatel gemäß Grünsystem für spezielle Anwendungen... 11

### S

Standard Mehrweg-Griffe... 19  
Standard Mehrweg-Spatel... 16  
Standard Mehrwegspatel für Spezialanwendungen... 18

### U

Universalscheren... 29

### Z

Zubehör... 25

## Française

### A

Accessoires... 25

### C

CALLANDER (modif. MACINTOSH) Lames réutilisables selon le système vert pour les applications spécialisées... 11  
Cartouche de réserve... 13, 19  
Ciseaux universels... 29

### F

FOREGGER - WISCONSIN Lames réutilisables selon le système vert... 8  
FOREGGER-WISCONSIN Lames réutilisables conventionnelles... 16

### H

HARTMANN Spéculum nasal... 30

### L

Lames réutilisables conventionnelles... 16  
Lames réutilisables conventionnelles pour les applications spécialisées... 18  
Lames réutilisables selon le système vert... 8-13  
Lames réutilisables selon le système vert pour les applications spécialisées... 10  
Lampe de réserve... 12  
Laryngoscope à usage unique... 2-5  
Laryngoscope à usage unique... 5

### M

MACINTOSH Lames de laryngoscope en plastique à usage unique en métal... 3  
MACINTOSH Lames réutilisables conventionnelles... 16  
MACINTOSH Lames réutilisables selon le système vert... 8  
MACINTOSH Laryngoscope à usage unique... 2  
MAGILL Pinzas de intubación... 28  
Manches conventionnels réutilisables... 19  
Manches réutilisables selon le système vert... 12-13  
MILLER Lames de laryngoscope en plastique à usage unique en métal... 3  
MILLER Lames réutilisables conventionnelles... 17  
MILLER Lames réutilisables selon le système vert... 9  
MILLER Laryngoscope à usage unique... 2

### P

POLIO Lames réutilisables selon le système vert pour les applications spécialisées... 11

### S

Sets de laryngoscopes... 22-24

## English

### A

Accessories... 25

### C

CALLANDER (modif. MACINTOSH) Green system reusable specialty blades... 11  
Conventional reusable blades... 16  
Conventional reusable handles... 19  
Conventional reusable specialty blades... 18

### F

FOREGGER - WISCONSIN Green system reusable blades... 8  
FOREGGER-WISCONSIN Conventional reusable blades... 16

### G

Green system reusable blades... 8-13  
Green system reusable handles... 12-13  
Green system reusable specialty blades... 10

### H

HARTMANN Nasal Speculum... 30

### L

Laryngoscope sets... 22-24

### M

MACINTOSH Conventional reusable blades... 16  
MACINTOSH Green system reusable blades... 8  
MACINTOSH Single use laryngoscope... 2  
MACINTOSH Single use metal plastic laryngoscope blades... 3  
MAGILL Intubation forceps... 28  
MILLER Conventional reusable blades... 17  
MILLER Green system reusable blades... 9  
MILLER Single use laryngoscope... 2  
MILLER Single use metal plastic

### L

laryngoscope blades... 3

### P

POLIO Green system reusable specialty blades... 11

### S

Single use laryngoscope... 2-5  
Single use laryngoscope handle... 5  
Spare cartridge... 12  
Spare lamps... 13, 19

### U

Universal Scissors... 29

**Italiana**

**A**

AAccessori ..... 25

**C**

CALLANDER (modif. MACINTOSH) Lame riutilizzabili secondo il sistema verde per applicazioni speciali ..... 11  
 Cartuccia di riserva ..... 12

**F**

Forbici universali ..... 29  
 FOREGGER - WISCONSIN Lame riutilizzabili secondo il sistema verde ..... 8  
 FOREGGER-WISCONSIN Lame convenzionali riutilizzabili ..... 16

**H**

HARTMANN Speculum nasale ..... 30

**L**

Lame convenzionali riutilizzabili ..... 16  
 Lame convenzionali riutilizzabili per applicazioni speciali ..... 18  
 Lame riutilizzabili secondo il sistema verde ..... 8-13  
 Lame riutilizzabili secondo il sistema verde per applicazioni speciali ..... 10  
 Lampada di ricambio ..... 13, 19  
 laringoscopio monouso ..... 2-5

**M**

MACINTOSH Lame convenzionali riutilizzabili ..... 16  
 MACINTOSH Lame per laringoscopio in plastica metallica monouso ..... 3  
 MACINTOSH Lame riutilizzabili secondo il sistema verde ..... 8  
 MACINTOSH laringoscopio monouso ..... 2  
 MAGILL Pinze per intubazione ..... 28  
 Manici convenzionali riutilizzabili ..... 19  
 Manici riutilizzabili secondo il sistema verde ..... 12-13  
 Manico per laringoscopio monouso ..... 5  
 MILLER Lame convenzionali riutilizzabili ..... 17  
 MILLER Lame per laringoscopio in plastica metallica monouso ..... 3  
 MILLER Lame riutilizzabili secondo il sistema verde ..... 9  
 MILLER laringoscopio monouso ..... 2

**P**

POLIO Lame riutilizzabili secondo il sistema verde per applicazioni speciali ..... 11

**S**

Set laringoscopio ..... 22-24

**NK**

NK9117	28
NK9120	28
NK9125	28
NK9217	28
NK9220	28
NK9225	28

**NL**

NL1302	10
NL1303	10
NL1304	10
NL1323	11
NL1324	11
NL1332	11
NL1333	11
NL1334	11
NL1399	8
NL1400	8
NL1401	8
NL1402	8
NL1403	8
NL1404	8
NL1405	8
NL1462	23
NL1463	23
NL1464	23
NL1483	22
NL1484	22
NL1499	9
NL1500	9
NL1501	9
NL1502	9
NL1503	9
NL1504	9
NL1512	9
NL1513	9
NL1514	9
NL1562	23
NL1563	23
NL1564	23
NL1582	22
NL1583	22
NL1584	22
NL1600	8
NL1601	8
NL1602	8
NL1603	8
NL1604	8
NL1663	23
NL1664	23
NL1683	22
NL1684	22
NL3302	18
NL3303	18
NL3304	18
NL3399	16
NL3400	16
NL3401	16
NL3402	16
NL3403	16
NL3404	16
NL3405	16
NL3463	24
NL3464	24
NL3499	17
NL3500	17
NL3501	17
NL3502	17

NL3503	17
NL3504	17
NL3512	17
NL3513	17
NL3514	17
NL3562	24
NL3563	24
NL3564	24
NL3599	16
NL3600	16
NL3601	16
NL3602	16
NL3603	16
NL3604	16
NL3663	24
NL3664	24
NL4420	3
NL4421	3
NL4422	3
NL4423	3
NL4424	3
NL4440	2
NL4441	2
NL4442	2
NL4443	2
NL4444	2
NL4445	2
NL4519	3
NL4520	3
NL4521	3
NL4522	3
NL4523	3
NL4524	3
NL4539	2
NL4540	2
NL4541	2
NL4542	2
NL4543	2
NL4544	2
NL5400	4
NL5401	4
NL5402	4
NL5403	4
NL5404	4
NL5499	4
NL5500	4
NL5501	4
NL5502	4
NL5503	4
NL5504	4
NL6000	12
NL6001	12
NL6002	12
NL6020	13
NL6021	13
NL6022	13
NL6110	19
NL6111	19
NL6120	19
NL6121	19
NL6122	19
NL6123	19
NL6310	5
NL6311	5
NL6800	13
NL6810	16-17, 19
NL6812	16-17, 19
NL6826	12
NL6903	25
NL6905	25
NL6907	25

NL6913	25
NL6915	25
NL6917	25
NL6923	25
NL6925	25
NL6927	25

**NS**

NS0291	30
NS0292	30
NS0293	30

**SY**

SY1318.NB	29
SY1318.NR	29
SY1318.NU	29





Starkling, mit Sitz in Deutschland, produziert ein komplettes Sortiment an Einweg- und Mehrweg-Laryngoskopen. Wir liefern an Krankenhäuser, Ambulanzen und Rettungsdienste in ganz Europa. Unsere wirtschaftlichen Produkte tragen dazu bei, die Intubationskosten zu senken und die Patientensicherheit zu erhöhen.

Basé en Allemagne, Starkling fabrique une gamme complète de laryngoscopes à usage unique et réutilisables. Nous fournissons des hôpitaux, des centres ambulatoires et des services de secours dans toute l'Europe. Nos produits économiques aident à réduire les coûts d'intubation et à améliorer la sécurité des patients.

Based in Germany, Starkling manufactures a complete range of single use and reusable laryngoscopes. We supply to hospitals, ambulatory centers and rescue services throughout Europe. Our products help reduce intubation costs yet enhance patient safety.

Con sede in Germania, Starkling produce una gamma completa di laringoscopi monouso e riutilizzabili. Forniamo a ospedali, centri ambulatoriali e servizi di soccorso in tutta Europa. I nostri prodotti economici contribuiscono a ridurre i costi di intubazione e a migliorare la sicurezza del paziente.



 **STARKLING**  
anesthesia

Starkling e.K.

 Rudolf-Diesel-Str. 18,  
78576 Emmingen-Liptingen, Germany

 +49 (7465) 3119927

 +49 (7465) 3119928

 [info@starkling-anesthesia.de](mailto:info@starkling-anesthesia.de)

 [www.starkling-anesthesia.de](http://www.starkling-anesthesia.de)

